

- ⑥ Output parameter setting : Main output low limit setting *4
 Main output high limit setting *4
 Main output changing rate limit setting *4
 Main output proportional cycle setting *4
 Main output filter time constant setting *4
 Main output ON-OFF action hysteresis low limit setting *4
 Main output ON-OFF action hysteresis high limit setting *4
 Sub-output low limit setting (Option)
 Sub-output high limit setting (Option)
 Sub-output changing rate limit setting (Option)
 Sub-output proportional cycle setting (Option)
 Sub-output filter time constant setting (Option)
 Sub-output ON-OFF action hysteresis low limit setting (Option)
 Sub-output ON-OFF action hysteresis high limit setting (Option)
 Sub-output dead band setting (Option)
 Main output dead band setting (Option)

- ⑦ Main setting value additional function setting: Main setting value low limit setting *3
 Main setting value high limit setting *3
 Main setting value rising rate setting *3
 Main setting value falling rate setting *3

- ⑧ Transmission output condition setting (Option): Transmission output selection (SV, PV and MV)
 Transmission output low limit value setting
 Transmission output high limit value setting

- ⑨ External setting input (Option) : External setting input range selection
 External setting input low limit value setting
 External setting input high limit value setting

- ⑩ Input setting : Scaling low limit value setting *3
 Scaling high limit value setting *3
 Decimal point place designation *4
 Input selection *3
 Unit selection *3
 Sensor correcting value setting *3
 Low level cut off function setting (Only when DC input) *3
 Square root extraction function designation (Only when DC input) *3
 Input value filter time constant setting *3

- ⑪ Communication parameter setting (Option): Data transfer rate selection
 Data length selection
 Parity selection
 Stop bit selection
 Instrument number setting

- ⑫ Cascade control parameter setting (Option): Slave Proportional band setting
Slave Integral time setting
Slave Derivative time setting
Slave Anti-reset windup (ARW) setting
Slave Proportional action offset setting
Slave PID auto-tuning setting
Slave PID auto-tuning bias setting
- ⑬ Cascade control input setting (Option): Slave input selection
Slave unit selection
Slave scaling low limit value setting
Slave scaling high limit value setting
Slave setting value low limit setting
Slave setting value high limit setting
- ⑭ Other functions : Running/Stopping selection
Remote setting/Local setting change (Option)
Setting value lock mode selection
LCD contrast adjustment
PID auto-tuning bias setting
External setting bias setting (Option)
Stopping status indicating contents selection
Instrument line frequency setting
Main control (Direct action/Reverse action) selection
Security function (Option)

Notes: *3, When cascade control (Option: CC), it functions as master side setting.
*4, When cascade control (Option: CC), it functions as both master side and slave side setting.

8.5 Indicating performance

- ① Indicating accuracy
Thermocouple input: Within $\pm 0.1\%$ of input range full scale ± 1 digit, however,
when R or S input, range 0 to 200°C ... Within $\pm 3^\circ\text{C}$
when T input, range -270 to -200°C ... Within $\pm 5^\circ\text{C}$
when B input, range 0 to 300°C ... Without the range of accuracy guarantee
(Cold junction compensating accuracy, $\pm 0.5^\circ\text{C}$ at $25^\circ\text{C} \pm 10^\circ\text{C}$)
RTD input : Within $\pm 0.1\%$ of input range full scale ± 1 digit
DC voltage or current input : Within $\pm 0.1\%$ of input range full scale ± 1 digit
- ② Sampling period : 0.1 seconds (However, in case the options External setting and/or Cascade control is applied, it is 0.2 seconds.)

8.6 Controlling performance

- ① Setting accuracy : The same as indicating accuracy
- ② Control action
 - PID action (w/auto-tuning function)
 - Proportional band (P) : 0.1 to 999.9% (Setting the PB to 0.0 (---) causes the instrument to act as an ON-OFF controller.)
 - Integral time (I) : 1 to 9999sec. (Setting the integral to 0 (---) disables the function.)
 - Derivative time (D) : 1 to 9999sec. (Setting the derivative to 0 (---) disables the function.)
 - Proportional band offset value : \pm Proportional band
 - Anti-reset windup(ARW): 0 to 100%

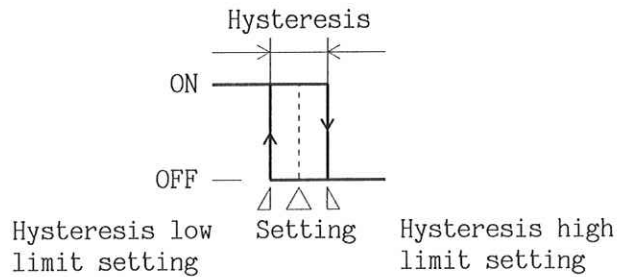
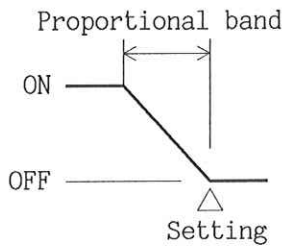

- Proportional cycle : 1 to 120sec. (Factory adjusted as 3sec. [-S/[]], 30sec. [-R/[]] not available [-A/[]])
- Output resolution : 1/10000 [-A/[]]
- Output limiter : 0 to 100.0% (-5.0 to 105.0% for Current output)
- Output changing rate limiter : 0 to 100.0%/sec. (Setting the changing rate limiter to 0.0, causes the output changing rate limit function off.)
- Output filter : 0 to 100.0sec.

- ③ Control output
 - Relay contact : 1a [-R/[]]
 - Control capacity : 220Vac 3A (resistive load)
220Vac 1A (inductive load $\cos\phi = 0.4$)
 - Non-contact voltage :(for SSR drive) [-S/[]]
15Vdc (load resistance 250 Ω to 1.2k Ω)
Maximum 20mAdc (short circuit protected)
 - Current : 4 to 20mAdc (Isolated type) [-A/[]]
load resistance, max. 600 Ω
Output resolution, 1/10000

8.7 Alarm function (A1)

① Kinds

Deviation setting by \pm to the main setting, and when input exceeds the range the output turns ON. [Alarm function disables when set to OFF]

		Model
High limit alarm	\pm scaling range span	[HCD-132-□/□]
Low limit alarm	\pm scaling range span	[HCD-133-□/□]
High/Low limits alarm	1 to scaling range span	[HCD-134-□/□]
High/Low limit range alarm	1 to scaling range span	[HCD-136-□/□]
Process value alarm	Scaling low to high limit setting value	[HCD-138-□/□]

② Alarm actions (A1 output)

• High limit alarm action

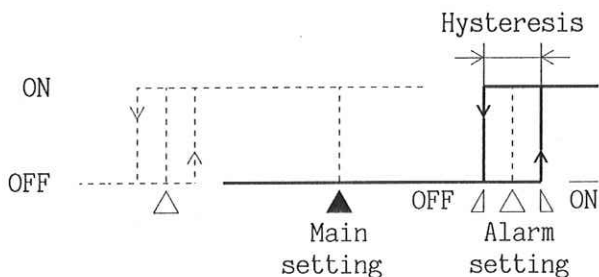

• Low limit alarm action

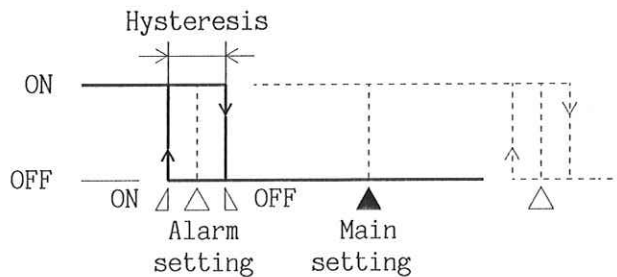

• High/Low limits alarm action

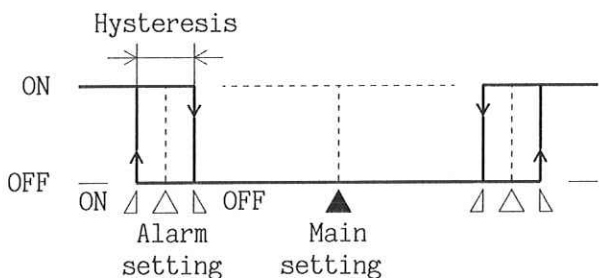

• High/Low limit range alarm action

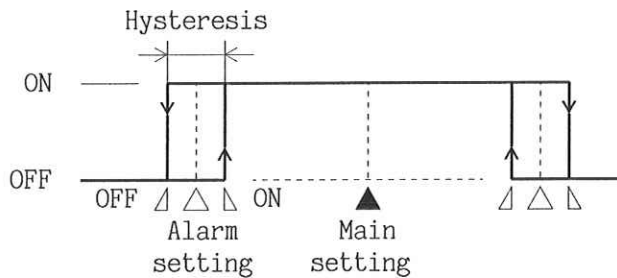

• Process value alarm action

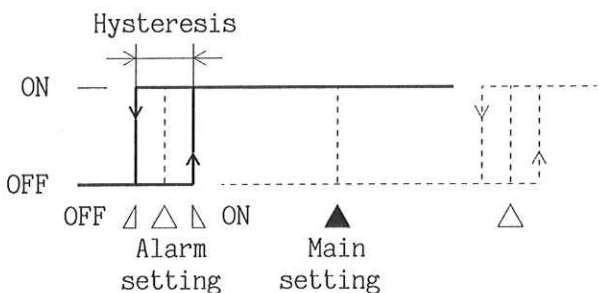

Note: Δ and ∇ mean the Hysteresis setting ON or OFF.

- * One kind of the alarm is specified.
- Setting accuracy: $\pm 0.1\%$ of full scale ± 1 digit
- Action : ON-OFF action
- Hysteresis : 0 to 999 (DC voltage or current)
0 to 99.9 or 0 to 99
(Thermocouple or RTD input)
- [corresponds to the decimal point place]
- (Hysteresis is set to the setting value individually ON and OFF.)
- Output : Relay contact 1a
Control capacity
220Vac 0.5A
(resistive load)
220Vac 0.2A
(inductive load $\cos \phi = 0.4$)

8.8 Other functions

① Multi-range function

Thermocouple input 10 kinds
 RTD input 1 kinds
 DC Voltage input 7 kinds
 DC Current input 2 kinds

② Input scaling function

Scaling for the thermocouple and RTD input are possible within the rated scale range of each range.

As for the voltage and current input, the scaling is possible within the range -19999 to 20000 against input value for each range.

Decimal point position can be set at will.

③ PV filter function

PV filter function is settable from 0.1 to 100.0sec. of primary digital low pass filter time constant. (OFF when set to 0)

④ Sensor correcting function

In case sensor mounting location differs from controlling location, it corrects the difference shifting the input value. Correctable: $\pm(10.0\%$ of scaling span).

⑤ Setting value ramp function

Setting value changing rate

Rise: Thermocouple, RTD input	0 to 9999.9/min. or 0 to 9999/min.
Voltage, Current input	0 to 99999/min. (Decimal point place is automatically changed)
Fall: Thermocouple, RTD input	-9999.9 to -0/min. or -9999 to 0/min.
Voltage, Current input	-99999 to 0/min. (Decimal point place is automatically changed)

When the power turned on, the control starts from the input value.

(This function disables if setting to 0.)

⑥ Control output direct and reverse change

It changes the action direct (cooling control) and reverse (heating control).

⑦ PID auto-tuning bias function

Bias value can be set so as not to exceed the PV than SV by auto-tuning action.

⑧ Setting value lock function

Setting value lock is selectable from 7 kinds of statuses undermentioned.

- Free : No lock function.
- All : Locks all of the setting values.
- Main set : Locks all of the setting values excepting setting value memory.
- PID : Locks all of the setting values excepting setting value memory and main setting.
- Alarm Set : Locks all of the setting values excepting setting value memory, main setting and PID setting.
- Alarm Func: Locks all of the setting values excepting setting value memory, main setting, PID setting and alarm setting.
- Temporary : Even if all of the setting values are changed, former values are kept when the power turned on again.

⑨ Control output OFF function

OFF : It stops the control output, and indicates "OFF" on PV display.

PV : It stops the control output, and indicates the process variable on PV display.

None: It stops the control output, and PV display indicates nothing.
Only the back-light is lit on LCD.

⑩ Balanceless bumpless function

AUTO → MANUAL When changed, manipulating value (MV) at which AUTO is operated becomes manual setting value.

MANUAL → AUTO When changed, MV at which MANUAL is operated is initialized to the MV when AUTO is operated.

⑪ Extraction of the square root operation function (Only when DC voltage or current input.)

Corresponds to the use of flow detection by differential pressure.

Function $PV' = \sqrt{PV}$ where PV : process variable
PV' : displayed and operated process variable

⑫ Low level cutoff function (Only when DC voltage or current input.)

When a process variable is near 0, square root extraction result will be largely changed correspond to a small input change, and the control result will be affected by the large change. This function prevents the influence.

Settable from 0 to 25.00% of span (% setting against to the input range)

⑬ Delayed starting timer setting

It does not start the control instantly after the power supply is turned on, but it starts the control after the preset time has elapsed.

Settable: Maximum, 99hours 59minutes

8.9 Option function

① Alarms with standby function (Option code: H)

When power is initially applied to the controller, the function disables alarm action even if the input value is in the range in which the alarm action works, and this also prevents the alarm even if the alarm action point enters the above range as a result of the main setting value change during control.

Once the input value exceeds the alarm action point continuing the control, the standby function will be released and when the input value reaches the point again, the alarm action output will work.

High limit alarm w/standby	± scaling range span	[HCD-132-□/□,H]
Low limit alarm w/standby	± scaling range span	[HCD-133-□/□,H]
Hi/Lo limits alarm w/standby	1 to scaling range span	[HCD-134-□/□,H]

• High limit alarm action w/standby

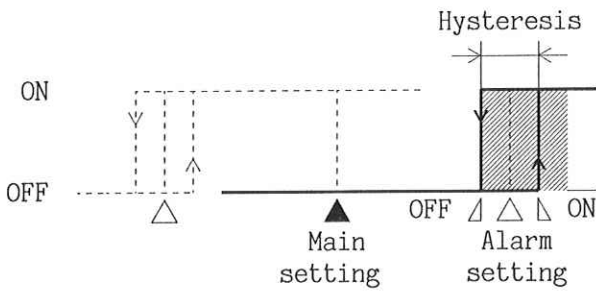

• Low limit alarm action w/standby

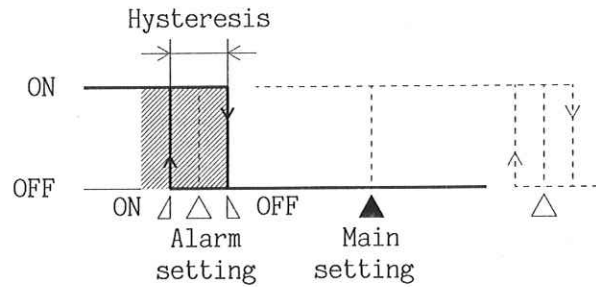

• High/Low limits alarm action w/standby

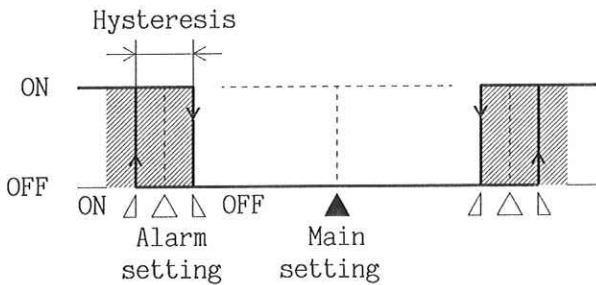

Notes: 1. \triangle and ∇ mean the Hysteresis setting ON or OFF.
 2. In parts the standby function works.

② Alarm [A2 output] (Option code: AL□)

Deviation setting by \pm to the main setting, and when input exceeds the range the output turns ON.

The same as temperature alarm A1 output. [Alarm function disables when set to OFF]

		Option code
High limit alarm	\pm scaling range span	AL2
Low limit alarm	\pm scaling range span	AL3
High/Low limits alarm	1 to scaling range span	AL4
High/Low limit range alarm	1 to scaling range span	AL6
Process value alarm	Scaling low to high limit setting value	AL8

• High limit alarm action

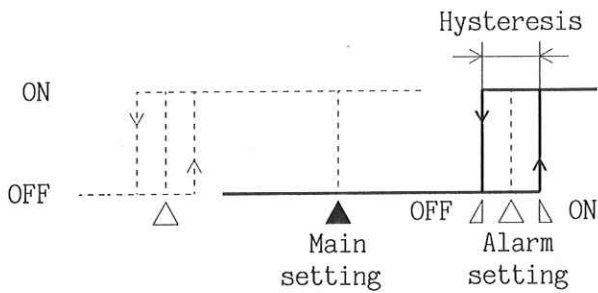

• Low limit alarm action

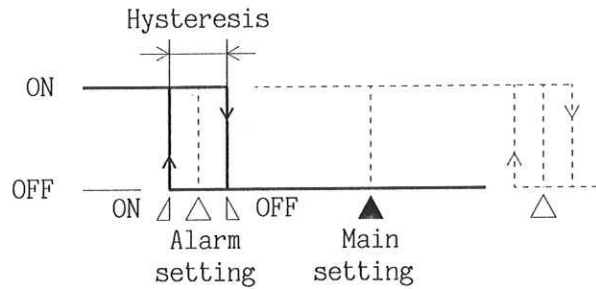

• High/Low limit alarm action

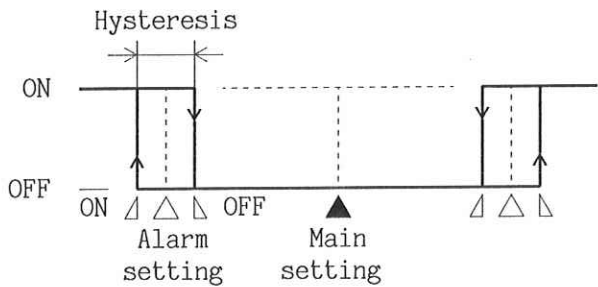

• High/Low limit range alarm action

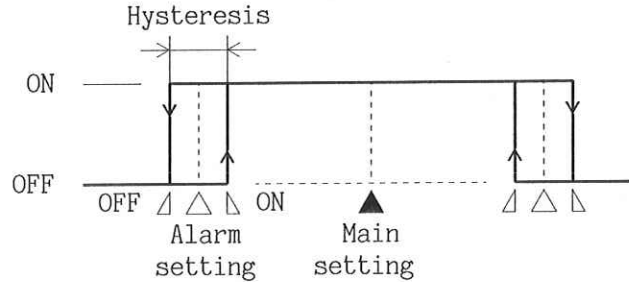

• Process value alarm action

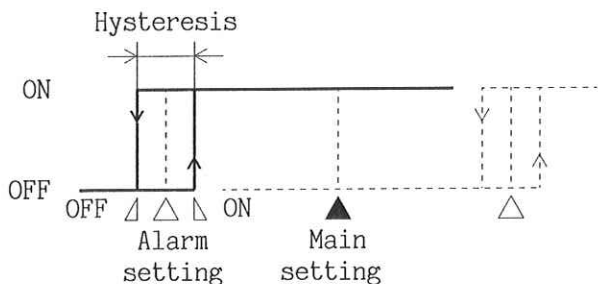

Note: \triangle and ∇ mean the Hysteresis setting ON or OFF.

③ Alarms with standby [A2 output] (Option code: AL□H)

When power is initially applied to the controller, the function disables alarm action even if the input value is in the range in which the alarm action works, and this also prevents the alarm even if the alarm action point enters the above range as a result of the main setting value change during control.

Once the input value exceeds the alarm action point continuing the control, the standby function will be released and when the input value reaches the point again, the alarm action output will work.

High limit alarm w/standby	± scaling range span	Option code
Low limit alarm w/standby	± scaling range span	AL2H
Hi/Lo limits alarm w/standby	1 to scaling range span	AL3H
		AL4H

• High limit alarm action w/standby

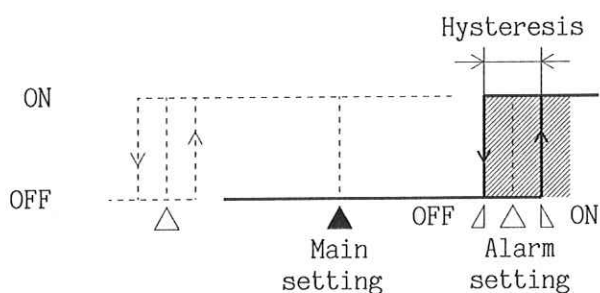

• Low limit alarm action w/standby

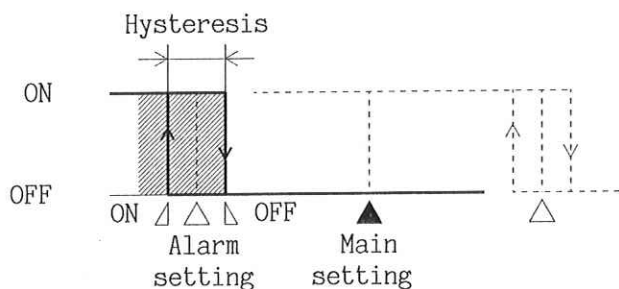

• High/Low limit alarm action w/standby

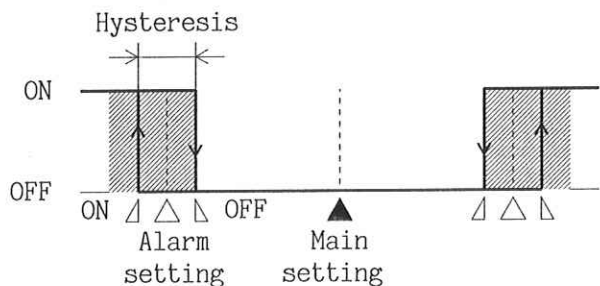

Notes: 1. Δ and ∇ mean the Hysteresis setting ON or OFF.
 2. In shaded parts the standby function works.

* One kind of the alarm is specified from above-mentioned.

Setting accuracy ±0.1% of full scale ±1 digit

Action ON-OFF action

Hysteresis, 0 to 999 for DC voltage and current input

0 to 99.9 or 0 to 99 for Thermocouple or RTD

(corresponds to the decimal point place)

(Hysteresis is set to the setting individually ON and OFF.)

Output

Relay contact 1a

Control capacity 220Vac 0.5A (resistive load)

220Vac 0.2A (inductive load $\cos\phi = 0.4$)

④ Alarm output (A3, A4 output) (Option code: SA)

Deviation setting by \pm to the main setting, and when input exceeds the range the output turns ON. The same as alarm A1 output, A3 and A4 can be selected from 8 kinds of alarms: High limit alarm, Low limit alarm, High/low limits alarm, High/low limit range alarm and Process value alarm, and additionally a standby function (Option H) is available for the High limit, Low limit and High/Low limit alarms.

• High limit alarm action

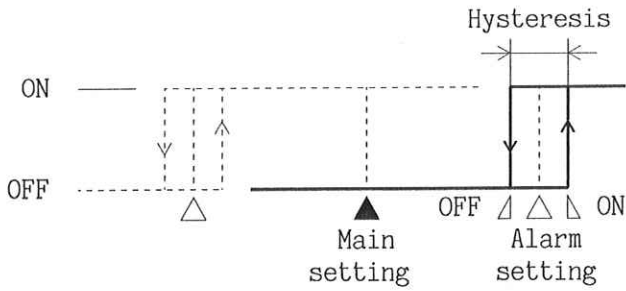

• Low limit alarm action

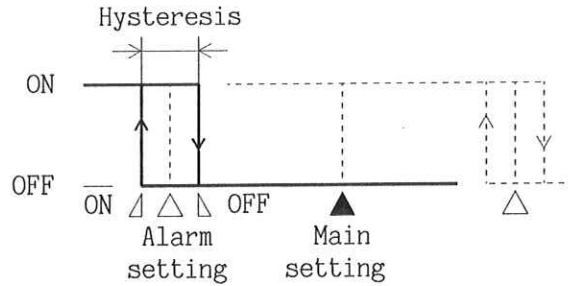

• High/Low limits alarm action

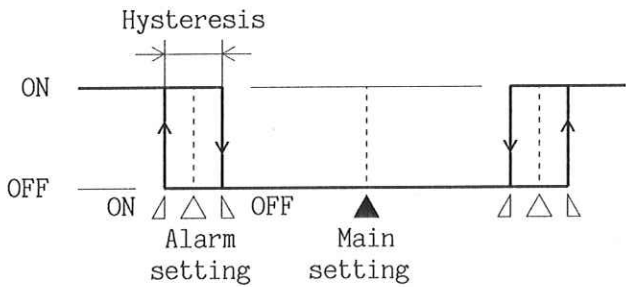

• High/Low limit range alarm action

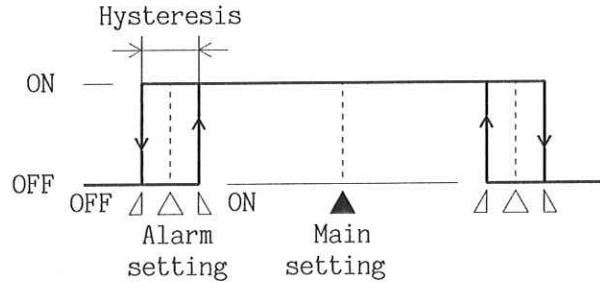

• Process value alarm action

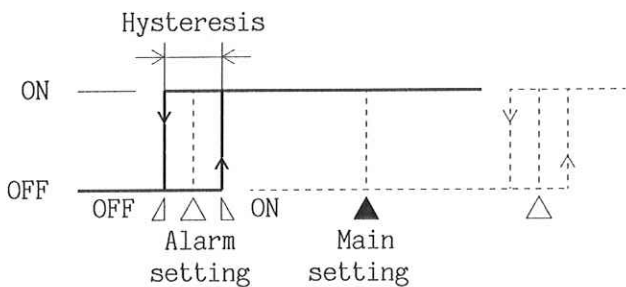

• High limit alarm action w/standby

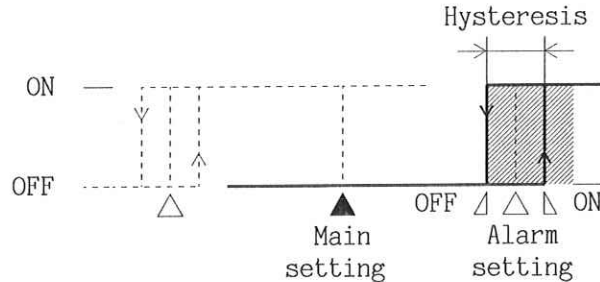

• Low limit alarm action w/standby

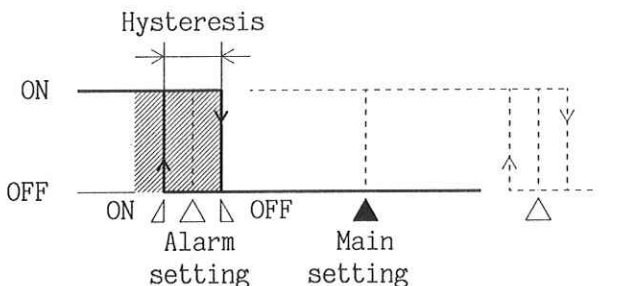

• High/Low limits alarm action w/standby

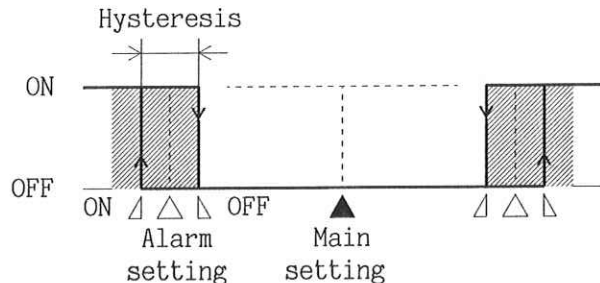

Notes: 1. Δ and ∇ mean the Hysteresis setting ON or OFF.
2. In parts the standby function works.

* A3 and A4 of the alarms are respectively specified from above-mentioned alarms.

Setting accuracy $\pm 0.1\%$ of range span ± 1 digit

Action ON-OFF action

Dead band, 0 to 999 for DC voltage or current input

0 to 99.9 or 0 to 99 for Thermocouple or RTD input

(corresponds to the decimal point place)

(Dead band is set against the setting individually ON and OFF.)

Output Open collector 2-point (A3, A4)

Control capacity 24Vdc 50mA maximum

⑤ Heating and cooling control output (Option code: D□)

Cooling (Sub-control)

Proportional band 0.1 to 999.9% (on/off action when set to 0.0 [---])

Derivative time 1 to 9999sec. (off when set to 0 [---])

Proportional cycle 1 to 120sec. (Factory adjusted as 3sec. -S/□, 30sec. -R/□, and not available for -A/□)

Overlap and Dead band setting range: -999 to 999 for DC voltage or current input

-99.9 to 99.9 or -99 to 99

for thermocouple or RTD input

(corresponds to the decimal point position)

Output [DR] Relay contact 1a

Control capacity 220Vac 3A (resistive load)

220Vac 1A (inductive load $\cos\phi=0.4$)

[DS] Non-contact voltage (for SSR drive)

15Vdc (load resistance 250 Ω to 1.2k Ω)

Maximum, 20mA dc (short circuit protected)

[DA] Current

4 to 20mA dc (Isolation type)

Load resistance : Maximum 600 Ω

Output resolution: 1/10000

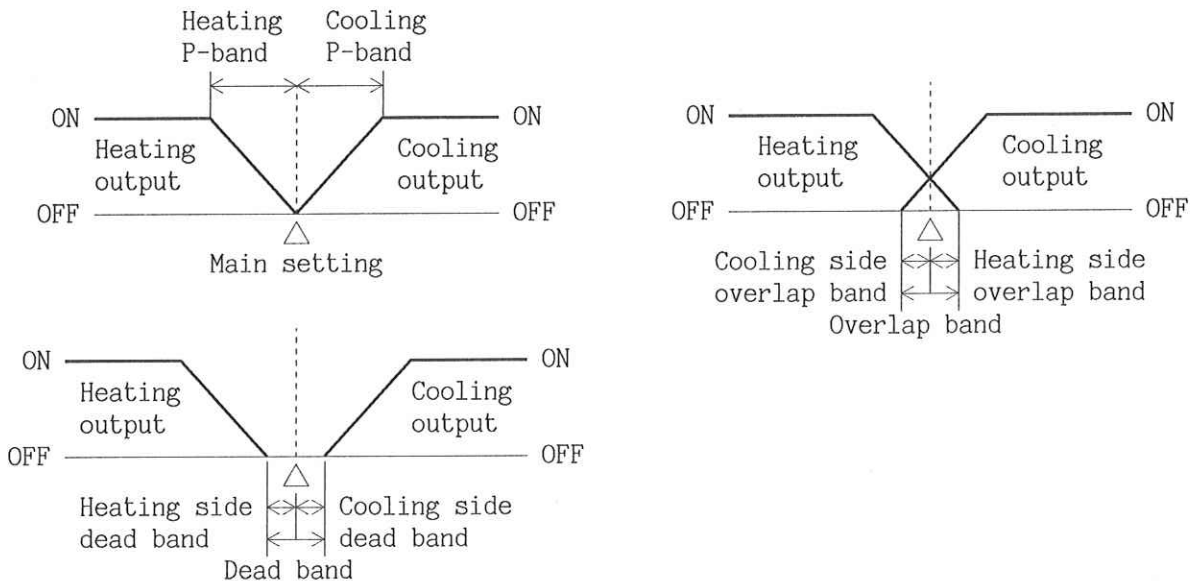

⑥ Transmission output (Option code: PVRTA,PVRTV. SVTA,SVTV. MVTA,MVTV)

Converting the value whichever PV transmission, SV transmission or MV transmission to analog signal (resolution: 1/10000) every 0.1 seconds, it outputs the value in current or voltage.

Current 4 to 20mA dc (load resistance maximum 600 Ω)

Voltage 0 to 1Vdc (load resistance minimum 10k Ω)

⑦ Serial communication

Following operation can be executed from the external computer.

- Reading and setting of the setting value such as Main setting, PID and ARW.
- Reading of the input value and action status.
- Change of the functions.

Communication circuit EIA RS-485 (Option code: C5) or RS-232C (Option code: C)
 Communication method Half-duplex communication start-stop synchronous
 Data transfer rate 300, 1200, 2400, 4800 and 9600bps (selectable)
 Data format Start bit : 1
 Data bit : 7 or 8
 Parity bit: 1 (even, odd or none, selectable)
 Stop bit : 1 or 2

⑧ Setting value memory number external change (Option code: SM)

It calls any file number (No.1 to 15) by external terminal connections from as many as 15 files memorized 14 kinds of data (Main setting value, Main PID values, ARW value, P-offset value, Sub PD values, Dead band value, Alarm [A1, A2, A3, A4] setting values).

The file number is selected connecting the terminals between each b0, b1, b2, b3 marked "○" and common.

File number selection by external terminals takes priority over a file number setting by front key operation.

If no terminals are connected, the file number will be selected as the front key operations. Auto/Manual are also settable by external change, if this option "SM" is applied. In case the option "E" is applied together with this option, external changes for Remote/Local can be performed.

No.	b3	b2	b1	b0
1				○
2			○	
3			○	○
4		○		
5		○		○
6		○	○	
7		○	○	○
8	○			
9	○			○
10	○		○	
11	○		○	○
12	○	○		
13	○	○		○
14	○	○	○	
15	○	○	○	○

⑨ Status output (Option code: SO)

It outputs ON or OFF correspond to each status of sensor burnout, remote and manual.

Output: Open collector, 24Vdc 50mA maximum

⑩ External memory function (Option code: DM)

It reads (LOAD) and writes (SAVE) the setting values with memory-card. [A memory-card is attached.]

⑪ External memory function (Option code: DMO)

It reads (LOAD) and writes (SAVE) the setting values with memory-card. [No memory-card is attached.]

(This option is applied when external memory is required, however, the memory-card is not required.)

⑫ External setting (Option code: E)

To change remote/local, it can be set by front sheet key operations or external signal.

Setting signal DC current 0 to 20mAdc, 4 to 20mAdc
 Input impedance, 10Ω
 When input burnout, downscale

DC voltage 0 to 1Vdc, 0 to 10Vdc and 1 to 5Vdc
 Input impedance, 1MΩ
 When input burnout, downscale

Setting signal sampling time, 0.2 seconds

Function, External scale setting

Setting range: from Scaling low limit setting value - Input scaling span/2
 to Scaling high limit setting value - Input scaling span/2

Minimum value: - 19999

Initial value: Input scaling span

⑬ Cascade control (Option code: CC)

It makes the input 1 to the primary controller input and input 2 to the secondary one.

One unit of HCD-130 allows to perform the cascade control.

(Option External setting is not applicable together with this function.)

(1) Rating of input 2

Input	Scale range		Resolution
K	0 to 1370.0°C	0 to 2500.0°F	0.1°C (°F) *
J	0 to 1000.0°C	0 to 1800.0°F	0.1°C (°F) *
R	0 to 1760.0°C	0 to 3200.0°F	0.1°C (°F) *
S	0 to 1760.0°C	0 to 3200.0°F	0.1°C (°F) *
PL-II	0 to 1390.0°C	0 to 2500.0°F	0.1°C (°F) *
B	0 to 1820.0°C	0 to 3300.0°F	0.1°C (°F) *
E	0 to 1000.0°C	0 to 1800.0°F	0.1°C (°F) *
T	-270.0 to 400.0°C	-450.0 to 750.0°F	0.1°C (°F) *
W/Re5-26	0 to 2315.0°C	0 to 4200.0°F	0.1°C (°F) *
N	0 to 1300.0°C	0 to 2300.0°F	0.1°C (°F) *
Pt100	-200.0 to 850.0°C	-200.0 to 1500.0°F	0.1°C (°F) *
DC	-1999.9 to 2000.0		1 *

*: Decimal point place is the same as the primary input one.

(2) Input	Thermocouple	K, J, R, S, PL-II, B, E, T, W/Re5-26 and N (JIS, IEC) Input impedance : 1M Ω or greater Signal source resistance effect: 0.5 μ V/ Ω When input burns out : Upscale (Downscale is applicable as well)
	RTD	Pt100 3-wire system (JIS, IEC) Allowable input lead wire resistance: Per wire 5 Ω or less When input burns out : Upscale
	DC voltage	0 to 10mVdc, -10 to 10mV, 0 to 100mVdc, 0 to 1Vdc, 0 to 10Vdc, -1 to 1Vdc and 1 to 5Vdc Input impedance : 1M Ω Allowable input voltage: 15V or less When input burns out : mV input, Upscale (Downscale is applicable as well) V input, Downscale
	DC current	0 to 20mAdc, 4 to 20mAdc Input impedance : 250 Ω When input burns out : Downscale

(3) Secondary controlling action

PID action (with auto-tuning function)

Proportional band (P) : 0.1 to 999.9% (Setting the PB to 0.0 causes the instrument to act as an ON-OFF controller.)

Integral time (I) : 1 to 9999sec. (Setting the integral to 0 disables the function.)

Derivative time (D) : 1 to 9999sec. (Setting the derivative to 0 disables the function.)

Proportional band offset: - Proportional band to + Proportional band

Anti-reset windup (ARW) : 0 to 100%

Proportional cycle : 1 to 120sec. (Factory adjusted as 3sec.[-S/[]], 30sec.[-R/[]], not available [-A/[]])

Output resolution : 1/10000 [-A/[]]

Output limiter *5 : 0.0 to 100.0% (-5.0 to 105.0% for Current output)

Output changing rate limiter *5 : 0 to 100.0%/sec

(Setting the output changing rate to 0 causes the function off.)

Output filter *5 : 0 to 100.0 seconds

*5: Common to the primary control (master) action.

* Sampling time : 0.2 seconds for both input 1 and input 2

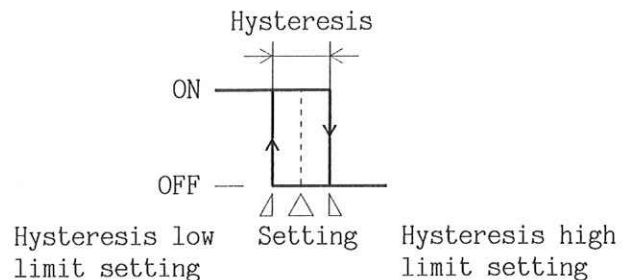
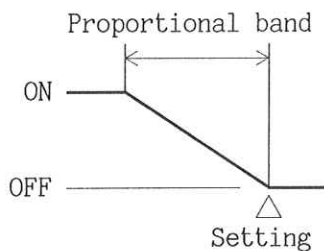

⑭ Security setting function (Option code: SE)

Setting the security levels (See page 55) and the security codes (4-digit) to secure the setting contents from wrong operation. (See page 54 to 56 for the detail.)

Setting value lock function cannot be applied together with this function.

8.10 Insulation and dielectric strength

- ① Insulation resistance
10M Ω or greater at 500Vdc (However, voltage must not be applied to the terminals for input and -S/ \square , -A/ \square output.)
- ② Dielectric strength
Between input terminal and ground terminal, 500Vac for 1 minute
Between power terminal and ground terminal, 1.5kVac for 1 minute
Between output terminal and ground terminal, 1.5kVac for 1 minute
(However, -S/ \square , -A/ \square , voltage must not be applied.)

8.11 Attached functions

- ① Power failure countermeasure
In case the power failure time exceeds 30ms, the data is backed up by lithium battery. The life of lithium battery is 10 years or greater at 20°C.
- ② Self-diagnosis
It watches the CPU by watchdog timer, and when abnormal status has happened, it makes the instrument to initial status making the all output OFF.
- ③ Automatic cold junction temperature compensation (- \square /E)
It detects the temperature at the connecting terminals between thermocouple and instrument, and always makes it the same status at which the reference junction is located at 0°C.
- ④ Burnout (Upscale)
When the thermocouple or RTD burns out, it makes the controlling output OFF and displays (- - - -) blinking on PV display.

8.12 Others

① Initial value for each setting value when shipped

Setting	Initial	Remarks
Main setting value	0	
Setting value memory number	1	
Proportional band	0(- - -)	
Proportional band (Sub-control)	0(- - -)	Option: "D□"
Integral time	0(- - -)	
Derivative time	0(- - -)	
Derivative time (Sub-control)	0(- - -)	Option: "D□"
Anti-reset windup (ARW)	30%	
Proportional band offset value	0	
Alarm 1 setting value	0 or OFF	when -132,-133,-138: 0 when -134,-136: OFF
Alarm 2 setting value	0 or OFF	Option: "AL□" when -132,-133,-138: 0 when -134,-136: OFF
Alarm 3 setting value	0	Option: "SA"
Alarm 4 setting value	0	Option: "SA"
Alarm 3 action system selection	OFF	Option: "SA"
Alarm 4 action system selection	OFF	Option: "SA"
Alarm 1 OFF action hysteresis setting value	1.0	When alarm designated
Alarm 1 ON action hysteresis setting value	0	When alarm designated
Alarm 2 OFF action hysteresis setting value	1.0	Option: "AL□, AL□H"
Alarm 2 ON action hysteresis setting value	0	Option: "AL□, AL□H"
Alarm 3 OFF action hysteresis setting value	1.0	Option: "SA"
Alarm 3 ON action hysteresis setting value	0	Option: "SA"
Alarm 4 OFF action hysteresis setting value	1.0	Option: "SA"
Alarm 4 ON action hysteresis setting value	0	Option: "SA"
Main output low limit setting value	0%	
Main output high limit setting value	100.0%	
Main output changing rate limit setting value	0%/s	
Main proportional cycle setting value	3s, 30s	S/□: 3sec. R/□: 30sec. A/□: not available
Main output filter time constant setting value	0.1s	
Main output ON-OFF action hysteresis low limit setting	0.5	
Main output ON-OFF action hysteresis high limit setting	0.5	
Sub-output low limit setting value	0%	Option: "D□"
Sub-output high limit setting value	100.0%	Option: "D□"
Sub-output changing rate limit setting value	0%/s	Option: "D□"

Setting	Initial	Remarks
Sub-proportional cycle setting value	3s, 30s	Option DS: 3s, DR: 30s DA: not available
Sub-output filter time constant setting value	0.1s	Option: "D□"
Sub-output ON-OFF action hysteresis low limit setting	0.5	Option: "D□"
Sub-output ON-OFF action hysteresis high limit setting	0.5	Option: "D□"
Sub-output dead band setting value	0	Option: "D□"
Main output dead band setting value	0	Option: "D□"
Main setting low limit setting value	*1	
Main setting high limit setting value	*2	
Main setting value rising rate setting value	0/m	
Main setting value falling rate setting value	0/m	
Transmission function selection	*3	Option: "□V T□"
Transmission output low limit setting value	*4	Option: "□V T□"
Transmission output high limit setting value	*5	Option: "□V T□"
External setting input range selection	*6	Option: "E□"
External setting low limit setting value	*1	Option: "E□"
External setting high limit setting value	*2	Option: "E□"
Scaling low limit setting value	*1	
Scaling high limit setting value	*2	
Decimal point place setting value	nnnn.n	
Input selection	*7	
Unit selection	none	
Sensor correction setting value	0	
Low level cutoff function setting	OFF	Not available when the input is TC or RTD.
Square root extraction function designation	OFF	Not available when the input is TC or RTD.
Input filter time constant setting	0s	
Transfer rate selection	9600bps	Option: "C" or "C5"
Data length selection	7bits	Option: "C" or "C5"
Parity bit selection	EVEN	Option: "C" or "C5"
Stop bit selection	1bit	Option: "C" or "C5"
Instrument number setting value	0	Option: "C" or "C5"
Slave proportional band setting value	0(- - -	Option: "CC"
Slave integral time setting value	0(- - -	Option: "CC"
Slave derivative time setting value	0(- - -	Option: "CC"
Slave anti-reset windup setting value	30%	Option: "CC"
Slave proportional band offset value	0	Option: "CC"

Setting	Initial	Remarks
Slave auto-tuning designation	STOP	Option: "CC"
Slave auto-tuning bias setting value	0	Option: "CC"
Slave input selection	*7	Option: "CC"
Slave unit selection	none	Option: "CC"
Slave scaling low limit setting value	*1	Option: "CC"
Slave scaling high limit setting value	*2	Option: "CC"
Slave setting low limit setting value	*1	Option: "CC"
Slave setting high limit setting value	*2	Option: "CC"
Control, running and stopping change	STOP	
Remote/Local change	LOCAL	Option: "E□"
Setting value lock mode selection	free	Not available if "SE"
LCD contrast adjusting value	40%	
PID auto-tuning bias setting value	0	
External setting bias setting value	0	Option: "E□"
Running mode stopping status indication selection	OFF	
Line frequency selection	60Hz	50 or 60Hz
Control mode Direct/Reverse selection	Reverse	
Security setting	level 5: code 0000	Set No. 0 Option: "SE"
	level 0: code 9999	Set No. 1 to 9 Option: "SE"

- *1. Low limit of rated input value
- *2. High limit of rated input value
- *3. Specified transmission output (SV, MV, PV)
- *4. Rated input low limit value (In case of MV: 0)
- *5. Rated input high limit value (In case of MV: 100.0)
- *6. Specified external setting input range (If not specified, 4 to 20mA_{dc})
- *7. Specified input kind

- ② Power consumption : Approx. 15W
- ③ Ambient temperature: 0 to 50°C
- ④ Ambient humidity : 35 to 85%RH (non-condensing)
- ⑤ Weight : Approx. 1kg
- ⑥ Accessories : Mounting bracket 1 set
Instruction manual 1 copy
Unit nameplate 1 sheet
Memory-card 1 sheet (for Option DM)

MEMO

MEMO

For any inquiry of this controller, after checking the following as to the controller, please contact your shop where purchased, or our agent.

[Example]

- Model HCD-130-R/E
- Temperature specification 0 to 1000.0°C
- Type of input J

In addition to the above, let us know the details of malfunction, if any, and the operating conditions specifically on job site.

Specifications subject to change without notice.

SHINKO TECHNOS CO., LTD.
OVERSEAS DIVISION

Reg Office : 2-48, 1-Chome, Ina, Minoo, Osaka, Japan
Mail Address: P.O.Box 17, Minoo, Osaka, Japan
Telephone : (0727)21-2781 & 2782

Telex: 5324127 (SHINKO J)
Cable: SHINKO MINOO JAPAN
FAX : (0727) 24-1760

No.HCD11E174